

Overview and Specifications

ComfoAir 200

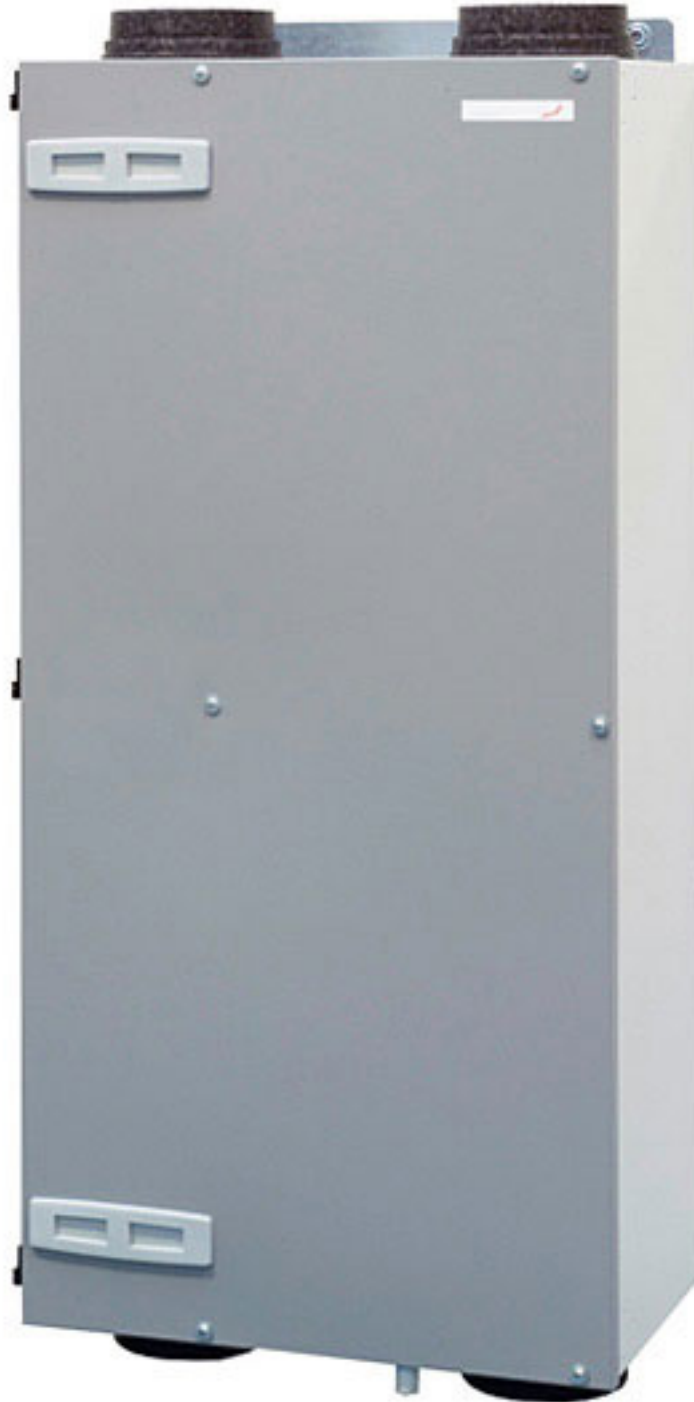

General Information

Use

The ComfoAir 200 ventilation unit was developed for residential and small commercial buildings. It combines maximum comfort, simple operation and very high efficiency. The CA200 exchanges up to 118 cfm of air at 0.80" wc. A ComfoAir 200 system is typically designed to exchange about 72 cfm in medium speed.

Efficiency

The integrated cross-counterflow heat exchanger achieves efficiencies of up to >90% in the HRV model. For user comfort this means no unpleasant cold drafts in winter, because the supply air is heated nearly to room temperature, even when external temperatures are very low.

Fans

The supply fan and extract fan are driven by efficient ECM DC motors. Differential pressures in the supply and extract air distribution systems can be adjusted thanks to individual control. The especially quiet fans can be adjusted to the required volumetric flow in 1% increments. The air volumes of the selectable stages can be set to between 29 cfm and 118 cfm.

Filters

The CA200 is equipped with two class G4 filters (MERV 7/8). An optional class F7 pollen filter (MERV 13) is available for fresh air intake.

Installation

The CA200 can be wall-mounted (vertically) or ceiling-mounted (horizontally). Connections for Supply and Return Air and wiring are on the top of the unit. Connections for Outside and Exhaust Air are on the bottom of the unit. The condensate drain is located on the bottom of the unit. The CA200 must be ordered as either a left-hand or a right-hand unit. This cannot be changed in the field.

Operation

The controls for the CA200 are accessed through the ComfoSense 67 controller, which may be installed in the mechanical room or anywhere in the living area. The ComfoSense is hard-wired to the CA200 with low-voltage cable. Additionally, hard-wired, low-voltage switches may be installed in the bathrooms, kitchen or any other room from which the user would like to initiate a timed boost mode.

Maintenance

Maintenance of the CA200 is limited to periodic cleaning or replacement of the filters accessible from the front of the unit. The exchanger core should be inspected and cleaned annually (depending on outside air quality). Please see the unit manual for additional servicing tasks.

Frost protection

The ComfoAir 200 is equipped with an automatic frost protection feature that will reduce supply air as necessary to keep condensation in the extract air from freezing and damaging the core. In extreme cold this may result in supply air being completely shut down for intermittent periods. Optional pre-heaters are available to enable continuous ventilation in cold climates. Optional electric resistance pre-heaters are also available, as either a smaller heater installed inside the CA200 or as a larger heater installed on the outside air duct outside the CA200.

Bypass

During summer nights and in the "shoulder" seasons of spring and fall with strong sunshine, the house can become too warm, while the outside temperature remains pleasantly cool. In such cases, heat removal by what is known as "free cooling" helps: The CA200 is equipped with a standard automatic bypass that diverts 100% of the relatively warm extract air from the heat exchanger, introducing cool supply air to the space.



Product Information

Optional Additions

- Humidity recovery with the Zehnder enthalpy exchanger
When the CA200 is fitted with an enthalpy exchanger core, the humidity from the extracted air is partly transferred to the fresh supply air. In this case, the process of drying out the house in dry winter months is delayed.
The Zehnder enthalpy exchanger provides the ideal hygienic solution. Supply and extract air flows are kept completely separate so there is no transfer of odors or bacteria.
- Pollen filter (F7/MERV 13)
A pollen filter installed in the intake air line (upstream of the heat exchanger) keeps the inside of the house pollen-free and reduces particulates, spores and germs so occupants can breathe freely in times of increasing allergies.
- Remote control
With the Zehnder remote control, the CA200 can be controlled from locations throughout the house, apartment, classroom, etc. Typically, one is installed in each bathroom to provide a boost function.
- Open fire program
The ventilation system can be installed in a home with a fireplace, wood stove, etc. but must be accounted for in the control unit. By indicating in the ComfoSense controller the presence of a fireplace, negative pressure and possible back-drafting of unpleasant fumes and/or harmful gases can be avoided.

Benefits

- Comfort ventilation up to a design rate of 69 CFM
- Heat recovery with an efficiency of >90% (HRV)
- Moisture recovery with optional Zehnder enthalpy exchanger
- Low power consumption thanks to DC motors
- Automatic summer bypass
- Electric post-heater integration
- Quick, safe installation, maintenance and servicing
- Frost Protection Function
- Optional, integrated electric pre-heater
- Wired remote control/boost switch
- Filter replacement indicator
- Simple Operation
- CO2 control (optional)
- Relative humidity control (optional)

Product Numbers

VV = integrated electric pre-heater

Product	Article Number	Product Number
CA200 HRV L	471 226 710	9280-01
CA200 HRV R	471 226 715	9276-01
CA200 HRV VV L	471 226 730	9281-01
CA200 HRV VV R	471 226 735	9338-01
CA200 ERV L	471 226 820	9357-02
CA200 ERV R	471 224 825	9364-02
CA200 ERV VV L	471 226 850	9422-01
CA200 ERV VV R	471 226 855	9423-01

Accessories	Article Number	Product Number
ComfoSense Control Unit	655 010 215	9257-01
Wired Boost Switch		9556-00
Waterless P-Trap	990 201 330	9362-00
Filters	Article Number	Product Number
G4 (MERV 7/8) 1 pc	400 100 014	9282-00
F7 (MERV 13) 1pc	400 100 013	9283-00

Technical Specifications

Heat Exchanger:	Plastic
Fans:	ECM direct current, radial fans
Filters:	(2) Class G4 (MERV 7/8), F7 (MERV 13) optional
Condensate Connection:	20mm
Air Duct Connections:	5" inside diameter (nominal); (2) top; (2) bottom.
Electrical Connection:	230V, 50-60Hz
Acoustic Performance:	Extract air (min – max): 30-57 dB(A) Supply air (min – max): 36-73 dB(A)
Heat Recovery:	>90% HRV
Volumetric Flow:	29cfm - 1560cfm
Power Consumption:	9W – 143W without preheater 900W +5%/-10% with preheater
Dimensions:	Height: 43.5" Width: 21.4" Depth: 12.7"
Weight:	66 pounds
Versions:	CA200 HRV L CA200 ERV L CA200 HRV R CA200 ERV R CA200 HRV VV L CA200 ERV VV L CA200 HRV VV R CA200 ERV VV R
Manufacturer:	Zehnder Group Nederland B.V. 8028 PM Zwolle NETHERLANDS

Dimensions

(Right Version Shown)

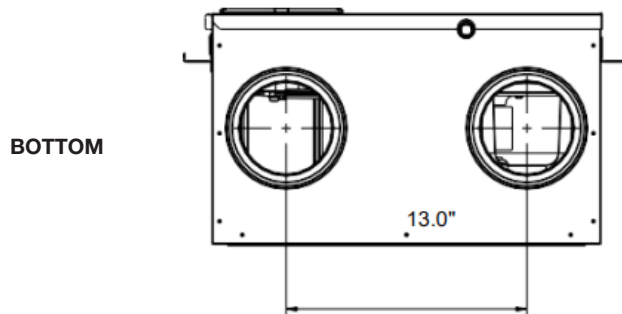
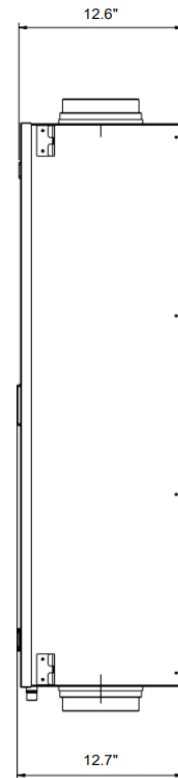
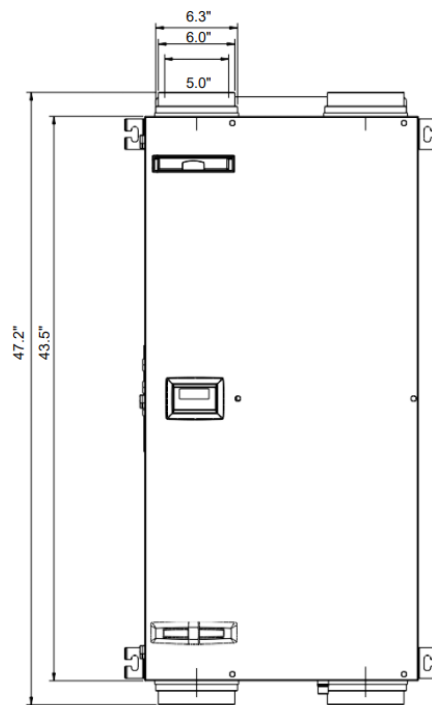
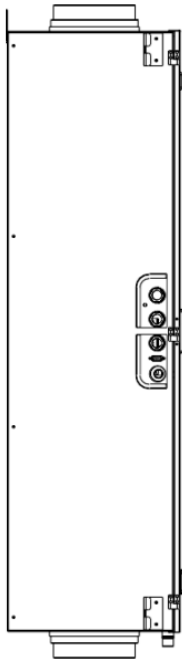
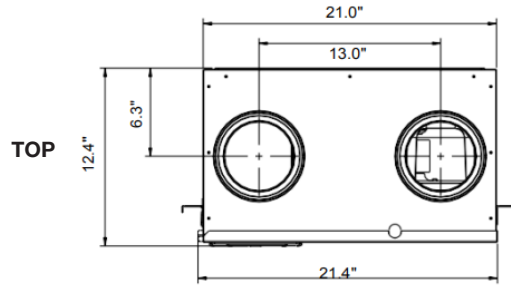

Pressure and Power Information

Stage	Setting	Capacity	Pressure	Power Consumption	Current Consumption	Cos	Installed noise level		Weight
	Percent	Qv	ΔP_{st}			φ	Extract air	Supply air	
	(rpm %)	cfm	*WC	w	A	(-)	dB(A)	dB(A)	lb
ComfoAir 200									
(1)	15%	12	0.012	9	0.08	0.48	30	36	66.2
(2)	30%	35	0.028	14	0.11	0.54	35	46	
(3) Low	40%	53	0.060	20	0.16	0.55	37	53	
(4)	50%	71	0.120	30	0.25	0.52	43	59	
(5)	60%	91	0.180	46	0.37	0.55	47	63	
(6) Medium	70%	109	0.281	68	0.55	0.54	51	66	
(7)	80%	127	0.402	98	0.77	0.55	54	69	
(8) High	90%	144	0.482	128	0.99	0.56	56	72	
(9) Maximum	100%	150	0.502	143	1.1	0.57	57	73	

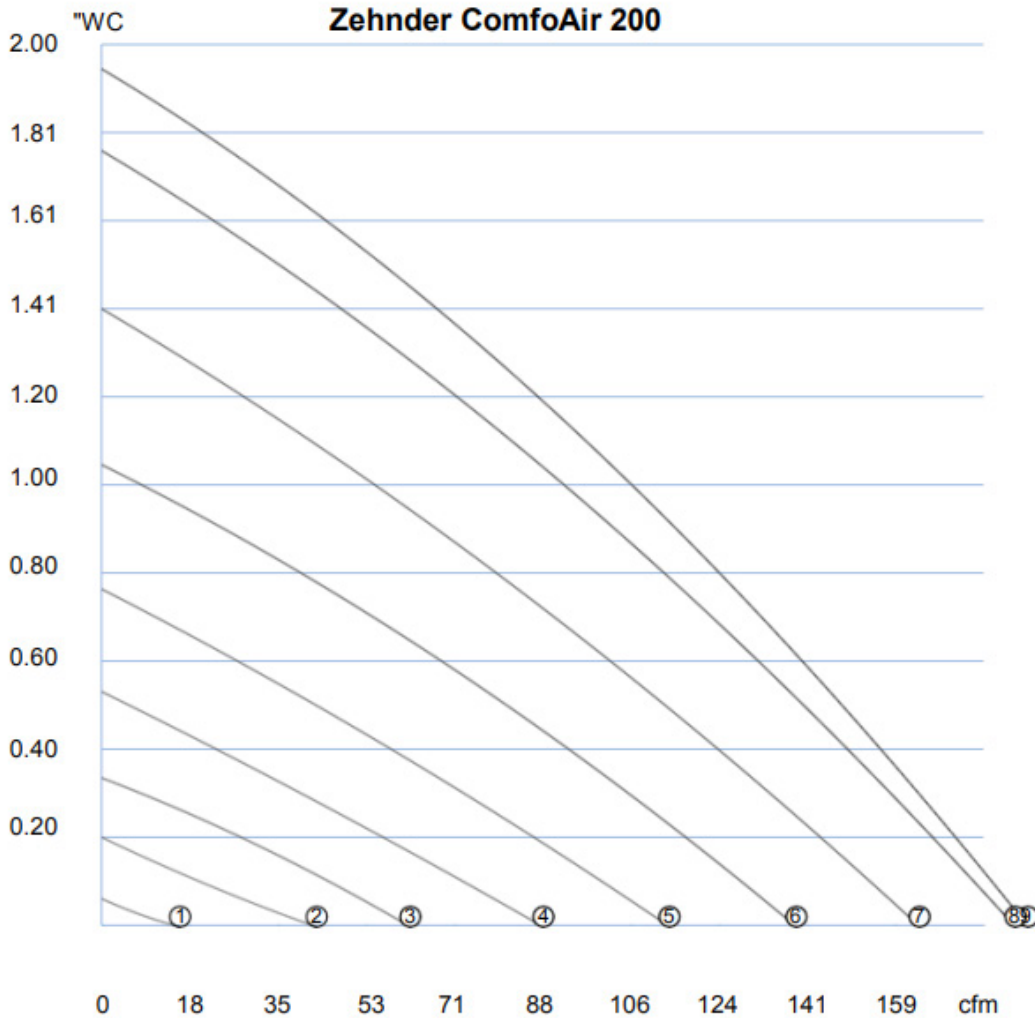

Sound Information

Sound, supply air

Acoustic performance at the intake air connection (at 0 feet)

Zehnder ComfoAir 200							
Speed	125 Hz	250 Hz	500 Hz	1000 Hz	2000 Hz	4000 Hz	8000 Hz
1	41.1	39.6	35.2	30	20.8	12.9	8.7
2	50.3	48.4	44.4	39.2	30	22.1	17.9
3	56	54.8	50.7	48.3	39.4	33.7	24.6
4	61.3	60.4	54.7	54.9	46	42.2	35.7
5	66.5	65.4	58.1	58.6	51.8	8.2	43.5
6	69.4	69.3	61.1	61.1	56.5	53.5	49
7	73.2	72.2	63.8	63.4	60.9	56.4	53.6
8	74.9	75.2	66.2	64.9	64	59.1	57
9	75.9	75.9	67.5	65.7	64.8	60.1	58.1

Sound, extract air

Acoustic performance at the extract air connection (at 0 feet)

Zehnder ComfoAir 200							
Speed	125 Hz	250 Hz	500 Hz	1000 Hz	2000 Hz	4000 Hz	8000 Hz
1	43.4	35.2	18.4	12.8	3.2	7.3	14.9
2	47.6	39.4	22.6	17	7.4	11.5	19.1
3	47.5	43.6	28.2	24.7	11.5	11.5	19
4	52	50.1	33.1	31.2	17.4	12.4	18.7
5	57	53.4	39.9	34.4	22.8	14.5	18.8
6	60.1	58	40.6	37	27.3	18.4	19.2
7	63.1	60.8	41.7	38.5	30.5	22.2	19.6
8	65.1	62.8	44.9	40.4	33.3	25.9	20.3
9	65.2	63.9	46.3	41.3	34.3	27.3	21

Sound, unit emission

Zehnder ComfoAir 200						
Speed	125 Hz	250 Hz	500 Hz	1000 Hz	2000 Hz	dB(A)
2	28.5	35.2	23.1	14.5	10.5	23.9
3	34.6	39.4	27.3	19.8	11.8	29.1
4	40.3	43.6	32.4	24.9	18.9	34.6
5	45.3	50.1	35.6	28.7	24.5	39
6	46.8	53.4	43.5	31.9	28.5	43.3
7	49.7	58	41.4	34.1	31.9	44.3
8	52.3	60.8	43.6	36	34.6	46.7
9	53.8	62.8	44.7	36.7	35.5	47.9

Zehnder America, Inc. 6 Merrill Industrial Drive, Suite 7 Hampton, NH 03842
 Phone: 603.601.8544 Toll Free: 888.778.6701 Fax: 603.601.8510
 Email: info@zehnderamerica.com <http://zehnderamerica.com/>