

Connection system

Zehnder ComfoPipe

Benefits

- Simple installation thanks to self-supporting, light components
- Tight-fitting, robust connections
- Great thermal insulation due to expanded polypropylene (EPP)
- Closed-cell and vapor-tight surface
- Fits on to ComfoAir Unit 160/200/350/550 connections.

Article numbers

Product	Art. no.	Reference No.
ComfoPipe duct length: 39", $\varnothing = 6.1"/5.0"$ (155/125)	990 328 672	9415
ComfoPipe duct length: 39", $\varnothing = 7.0"/6.0"$ (180/150)	990 328 641	9290
ComfoPipe duct length: 39", $\varnothing = 8.3"/7.0"$ (210/180)	990 328 651	9291
ComfoPipe bend 90°, $\varnothing = 6.1"/5.0"$ (155/125)	990 328 673	9416
ComfoPipe bend 90°, $\varnothing = 7.0"/6.0"$ (180/150)	990 328 643	9294
ComfoPipe bend 90°, $\varnothing = 8.3"/7.0"$ (210/180)	990 328 653	9295
ComfoPipe sleeve = 5.0" (125)	990 328 675	9418
ComfoPipe sleeve = 6.0" (150)	990 328 644	9296
ComfoPipe sleeve = 7.0" (180)	990 328 654	9297
ComfoPipe junction 1, $\varnothing = 7.0"/6.0"$ (180/150)	990 328 662	9298



Description

ComfoPipe system: Insulated, vapor-tight, made of EPP plastic, lightweight.

Insulated ComfoPipe ventilation tube. The pipe system comprises tubes of 39" (1000) length, 90° bends and sleeves. The tubes can be shortened to fit. 90° bends can be cut to 45° bends on cut line. Fast and simple installation, low weight, good thermal insulation.

Connection system

Zehnder ComfoPipe

Dimensions

Tube

D1	D2	D3	L
5.0" (125)	6.1" (155)	7.3" (185)	39" (1000)
6.0" (150)	7.0" (180)	8.3" (210)	39" (1000)
7.0" (180)	8.3" (210)	9.4" (240)	39" (1000)

90° bend

5.0" (125)	6.1" (155)	7.3" (185)	7.9"
6.0" (150)	7.0" (180)	8.3" (210)	7.9"
7.0" (180)	8.3" (210)	9.4" (240)	8.5"

Sleeve

5.0" (125)	6.1" (155)	7.3" (185)	3.4"
6.0" (150)	7.0" (180)	8.3" (210)	3.4"
7.0" (180)	8.3" (210)	9.4" (240)	3.4"

Dimensional drawing

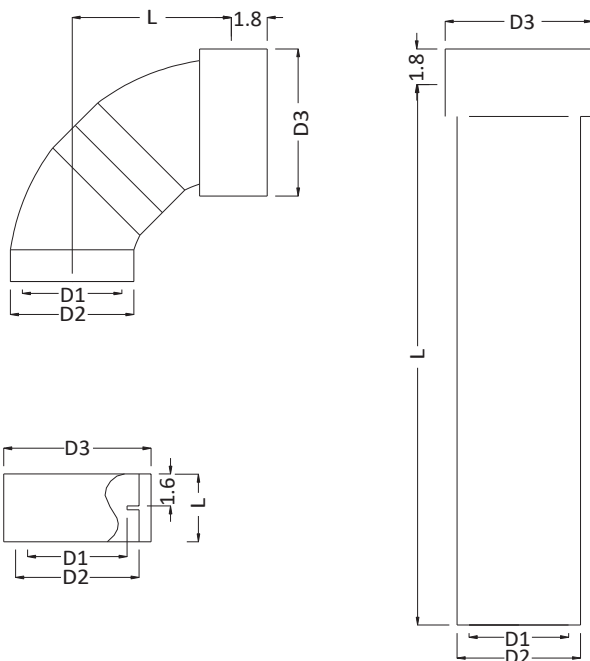

Connection system

Zehnder ComfoPipe

Specifications

Specifications	Material	EPP plastic
Dimensions	Material thickness:	0.60"
	Thermal resistance:	R 2.3
	Applications:	-13°F to +140°F
	Elasticity:	30%

Pressure losses

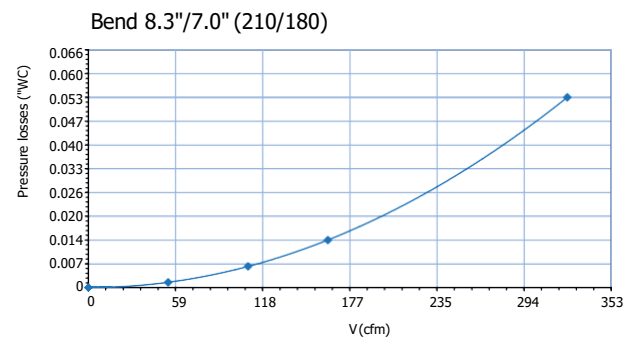
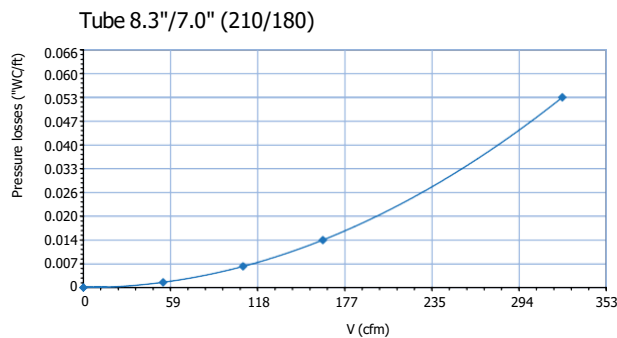
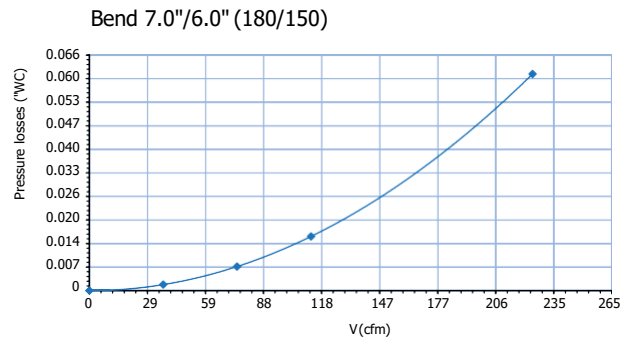
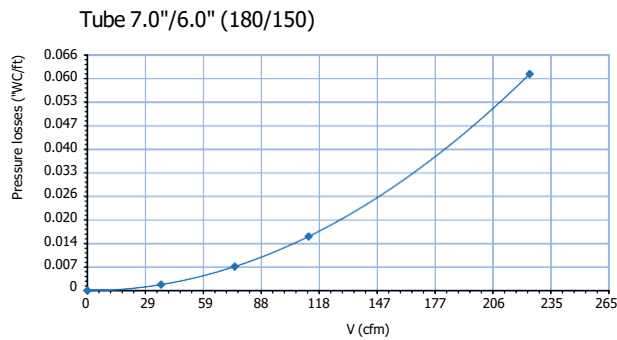
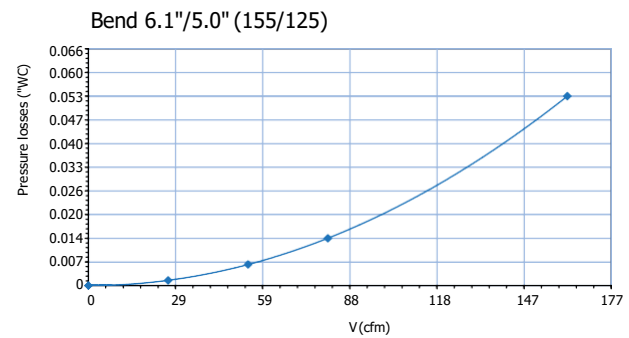
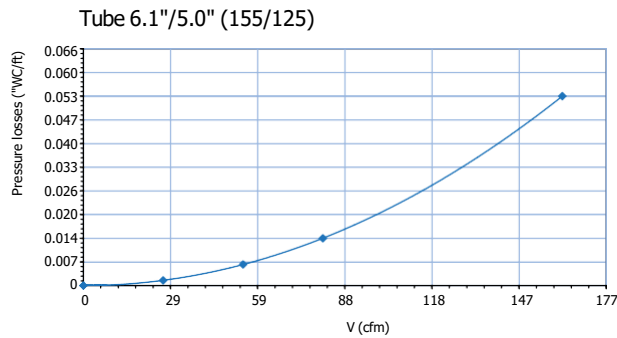

ZA-CSY-FLYERTS078, V11 2014, en_us, subject to changes